

STT800GKXXPT

Thyristor-Thyristor Modules

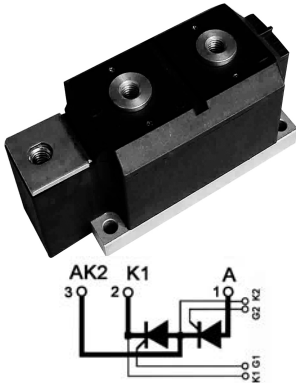

Type	V_{RSM} V_{DSM} V	V_{RRM} V_{DRM} V
STT800GK08PT	900	800
STT800GK12PT	1300	1200
STT800GK14PT	1500	1400
STT800GK16PT	1700	1600
STT800GK18PT	1900	1800

Colerance: $\pm 0.5\text{mm}$
Dimensions in mm (1mm=0.0394")

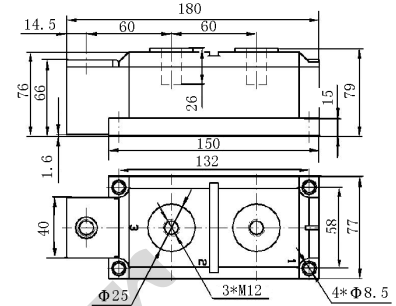

Symbol	Test Conditions	Maximum Ratings	Unit
ITAV	$T_C=85^\circ\text{C}$; 180° half sine wave, 50HZ	800	A
ITRMS	$T_C=85^\circ\text{C}$; 180° Full cycle sine wave, 50HZ	1256	A
ITSM	$T_V= T_{VJM}$ $T_C=25^\circ\text{C}$ 180° half sine wave, 50HZ single pulse; $V_R=0$;	30.0 35.0	A
I^2t	$T_V= T_{VJM}$ $T_C=25^\circ\text{C}$ Gate pulse; 20V, 5W 1us rise time, 500us	4500 6125	
V_{DRM} , V_{RRM}	$T_V= T_{VJM}$ 180° half sine wave, 50HZ ; Gate open	1000/1800	A ² s
V_{DSM} , V_{RSM}	$T_V= T_{VJM}$ 180° half sine wave, 50HZ ; single pulse, Gate open	1100/1900	
$(di/dt)_{cr}$	$T_V= T_{VJM}$ $f=50\text{Hz}$, $t_p=200\mu\text{s}$ $V_D=2/3V_{DRM}$ $I_G=1\text{A}$ $di/dt=1\text{A}/\mu\text{s}$	repetitive, $I_T=960\text{A}$ 100	A/ μs
		non repetitive, $I_T=I_{TAVM}$ 200	
$(dv/dt)_{cr}$	$T_V= T_{VJM}$; $R_{GK}=\infty$; method 1 (linear voltage rise)	$V_{DR}=2/3V_{DRM}$ 1000	V/ μs
P _{GM}	$T_V= T_{VJM}$	40	W
P _{GAV}	$T_V= T_{VJM}$	6	W
V _{RGM}	$T_V= T_{VJM}$	5	V
T_{VJ} T_{VJM} T_{stg}		-40...+140 140 -40...+125	$^\circ\text{C}$
V _{ISOL}	50/60Hz, RMS $I_{ISOL}\leq 1\text{mA}$	$t=1\text{min}$ $t=1\text{s}$ 3000 3600	V~
M _d	Mounting torque (M6) Terminal connection torque (M8)	4.5-7/40-60 11-13/97-115	Nm/lb.in.
Weight	Typ.	3249	g

STT800GKXXPT

Thyristor-Thyristor Modules

Symbol	Test Conditions	Characteristic Values	Unit
I_{RRM}	$T_{VJ}=T_{VJM}; V_R=V_{RRM}$	70	mA
V_T	$I_T=1200A; T_{VJ}=25^{\circ}C$	1.55	V
V_{TO}	For power-loss calculations only ($T_{VJ}=T_{VJM}$)	0.9	V
r_T		0.21	mΩ
V_{GT}	$V_D=12V$ $T_{VJ}=25^{\circ}C$ $T_{VJ}=-40^{\circ}C$	2.5 3.5	V
I_{GT}	$V_D=12V$ $T_{VJ}=25^{\circ}C$ $T_{VJ}=-40^{\circ}C$	300 400	mA
V_{GD}	$T_{VJ}=T_{VJM}; V_D=2/3V_{DRM}$	0.5	V
I_{GD}	$T_{VJ}=T_{VJM}; V_D=2/3V_{DRM}$	10	mA
I_L	$T_{VJ}=25^{\circ}C; t_p=30\mu s; V_D=12V$ $I_G=1A; di/dt=1A/\mu s$	1000	mA
I_H	$T_{VJ}=25^{\circ}C; V_D=6V; R_{GK}=\infty$	500	mA
t_{gd}	$T_{VJ}=25^{\circ}C; V_D=1/2V_{DRM}$ $I_G=1A; di/dt=1A/\mu s$	10	us
t_q	$T_{VJ}=T_{VJM}; I_T=500A; t_p=200\mu s; -di/dt=10A/\mu s$ $V_R=100V; dv/dt=50V/\mu s; V_D=2/3V_{DRM}$	200	us
R_{thJC}	DC current	0.0405	K/W
R_{thJK}	DC current	0.01	K/W
ds	Creeping distance on surface	12.7	mm
da	Creepage distance in air	9.6	mm
a	Maximum allowable acceleration	59.81	m/s ²

FEATURES

- * International standard package
- * Copper base plate
- * Isolation voltage 3600 V~
- * UL file NO.310749
- * RoHs compliant

APPLICATIONS

- * Motor control, softstarter
- * Power converter
- * Heat and temperature control for industrial furnaces and chemical processes
- * Lighting control
- * Solid state switches

ADVANTAGES

- * Simple mounting
- * Improved temperature and power cycling
- * Reduced protection circuits



STT800GKXXPT

Thyristor-Thyristor Modules

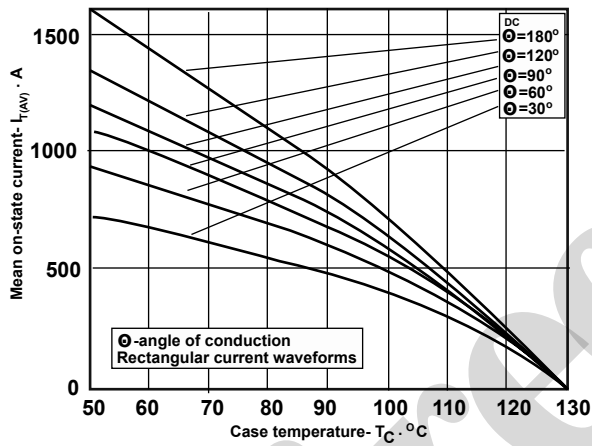
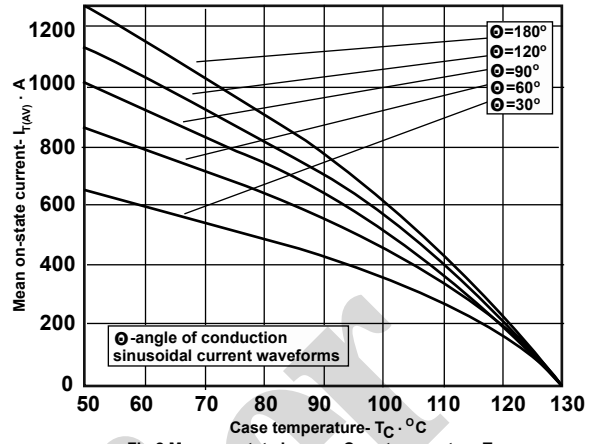
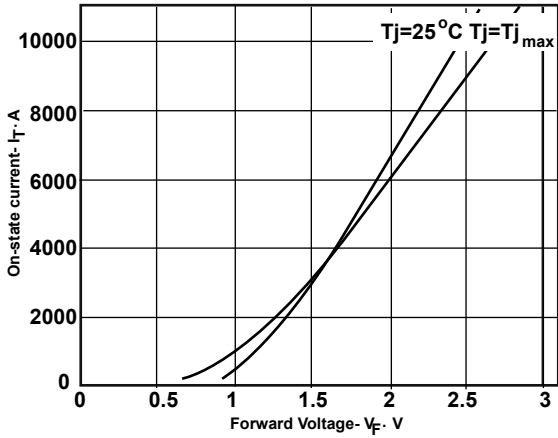

Fig 3 Mean on-state $I_{T(AV)}$ vs. Case temperature T_C for rectangular current waveforms at different conduction angles and for DC, $f=50Hz$

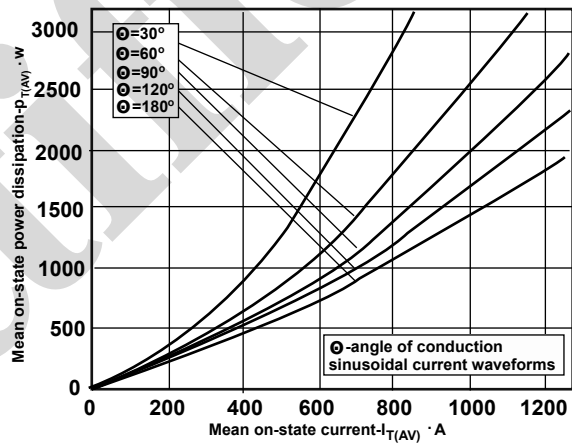

Fig 4 Mean on-state power dissipation $P_{T(AV)}$ vs. Mean on-state current $I_{T(AV)}$ for sinusoidal current waveforms at different conduction angles, $f=50Hz$

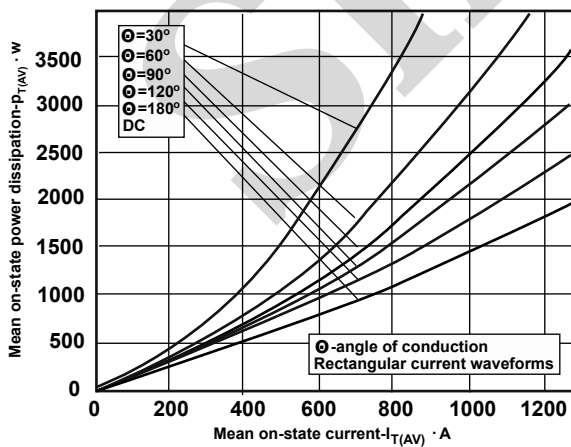

Fig 5 Mean on-state power dissipation $P_{T(AV)}$ vs. Mean on-state current $I_{T(AV)}$ for rectangular current waveforms at different conduction angles and for DC, $f=50Hz$

STT800GKXXPT

Thyristor-Thyristor Modules

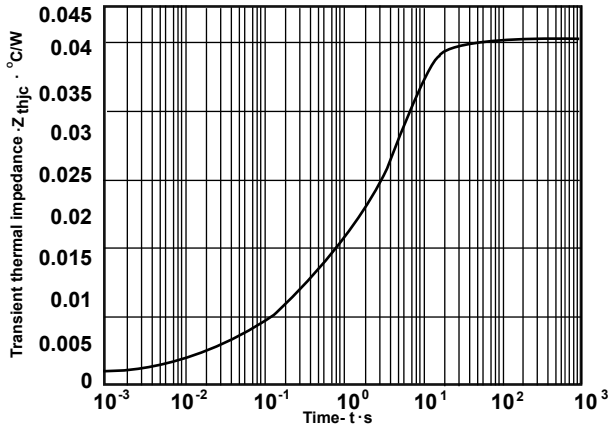

Fig 6 Transient thermal impedance junction to case Z_{thjc} per arm for DC

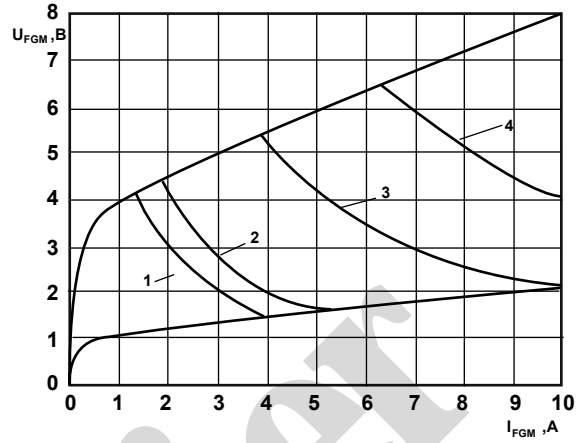

Fig 7 Gate characteristic